



Polyboard Range

Recycled plastic is an increasingly popular material, and is now available in a range of colour options for seats, benches, litter bins and picnic furniture. Polyboard seats can be supplied with flush mounted commemorative plaques in engraved stainless steel, or cast bronze. Carved inscriptions are also possible, though only on some colours of plastic. The recycled plastic is made from a range of waste plastics, its main constituents being low and high density polyolefins. All of our seats and benches in this range have three full frames to prevent the sagging that unsupported recycled

plastic is prone to. In certain circumstances, particularly if an accelerant such as petrol is used, this material may catch fire and burn.

Recycled plastic has the following benefits:

- **Ecologically attractive**
- **Long lasting and durable**
- **Knot and splinter free**
- **No painting required**
- **Water resistant, rot free**
- **Maintenance free**
- **Comfortable to sit on**
- **Through coloured**

STIRLING SEAT

Organic curves distinguish this seat, which has wider, shaped board on the base and back. Available with either mild and stainless steel frames, and with extended legs to concrete in as standard. Stainless steel framed versions use grade 316, satin polished, and are illustrated on page 32.

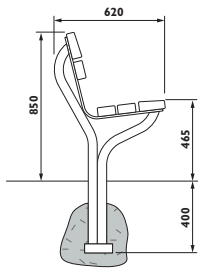

Stirling Seat



Stirling Seats with coloured polyboards

- Two tapered 45/55 x 145mm and three 50 x 95mm polyboards in black as standard
- Also available with five 50 x 95mm polyboards in brown, (or blue, green, red or yellow at additional cost)
- Frames 50 x 3mm circular hollow and 50 x 12mm flat
- Length 1800mm, weight approx. 75kg.
- Supplied with extended legs (for concreting in), as standard. Also available, at additional cost, with pedestal base legs (for bolting down).
- Pedestal base option can be bolted down with K1 rawl bolts, K4 extended rawl bolts or K12 extended rawl bolts
- Frames finished in either Acrylic Coating or Street-Tough in green 14C39 as standard (see page 82), eleven other colour



Stirling Seat

- options at no extra cost (see page 85)
- Stainless steel pin-in-socket fastenings as standard
- Supplied as separate boards and frames, requiring assembly
- For installation recommendations see page 44

TENBY SEAT

A development of our Colwyn seat, a wider, shaped, board on the base and back make this seat particularly comfortable. The frames are blue 20C40 as standard, though the black frames illustrated here are an option at no extra cost.

- Two tapered 45/55 x 145mm and three 50 x 95mm polyboards in black only
- Frames 50 x 50 x 3mm hollow with 50 x 100 x 3mm hollow legs
- Length 1800mm, weight approx. 69kg

- Supplied with extended legs (for concreting in), as standard. Also available with either pedestal base legs (for bolting down), or ground anchoring version (see pages 74 -75).
- Pedestal base option can be bolted down with K3 rawl bolts, or K10 extended rawl bolts
- Frames finished in either Acrylic Coating or Street-Tough in dark blue 20C40 as standard (see page 82), eleven other colour options at no extra cost (see page 85)
- Stainless steel pin-in-socket fastenings as standard
- Supplied as separate boards and frames, requiring assembly
- For installation recommendations see page 44

Polyboard Range



Tenby Seat



Tenby Seat with arms

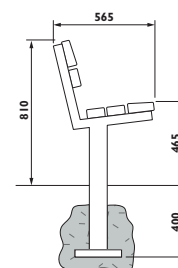

COLWYN SEAT



Colwyn Seat with black frames



Colwyn Seat with arms



Colwyn Seat with black frames and red boards

This polyboard equivalent of our Monmouth seat is very cost effective and suitable for general park, play area and street use. The frames are dark green 14C40 as standard, though black frames are an option at no extra cost.

- Polyboards 50 x 95mm
- Polyboards in brown as standard, also available in black, (or blue, green, red or yellow at additional cost)
- Frames 50 x 50 x 3mm hollow with 50 x 100 x 3mm legs
- Length 1800mm, weight approx. 62kg
- Supplied with extended legs (for concreting in), as standard. Also available with either pedestal base legs (for bolting

down), or ground anchoring version (see pages 74 - 75)

- Pedestal base option can be bolted down with K3

rawl bolts, or K10 extended rawl bolts

- Frames finished in either Acrylic Coating or Street-Tough in dark green 14C40 as standard (see page 82), eleven other colour options at no extra cost (see page 85)
- Stainless steel pin-in-socket fastenings as standard
- Supplied as separate boards and frames, requiring assembly
- For installation recommendations see page 44

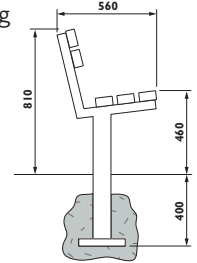

BARMOUTH SEAT

An attractive and very comfortable seat, combining elements of traditional design with modern materials. Three full frames properly support the recycled plastic boards, which are secured to the frames by countersunk stainless steel cap head bolts.

- Polyboards 50 x 50mm in black as standard, also available in blue, green, red or yellow at additional cost
- Frames 50 x 12mm flat, 76 x 3mm circular hollow and 80 x 20mm flat
- Length 1800mm, weight approx. 71kg.
- Supplied with extended legs (for concreting in), as standard. Also available with pedestal base legs (for bolting down)
- Pedestal base option can be bolted down with K1 rawl bolts, K4 extended rawl bolts or K12 extended rawl bolts
- Frames finished in either Acrylic Coating or Street-Tough in

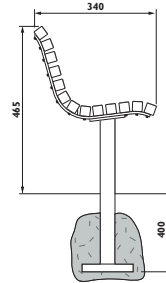

Barmouth Seat

green 14C39 as standard (see page 82), eleven other colour options at no extra cost (see page 85)

- Supplied partially assembled, with legs to bolt on
- For installation recommendations see page 44

SHEFFIELD BENCH

Designed to partner the Stirling seat, the tulip shaped frames of this bench look very elegant. It has two wider, shaped boards on the base. Available with either mild and stainless steel frames, and with extended legs to concrete in as standard. Stainless steel framed versions use grade 316, satin polished, and are illustrated on page 32.

- Two tapered 45/55 x 145mm and one 50 x 95mm polyboard in black only
- Frames 50 x 3mm circular hollow and 50 x 12mm flat
- Length 1800mm, weight approx. 46kg.

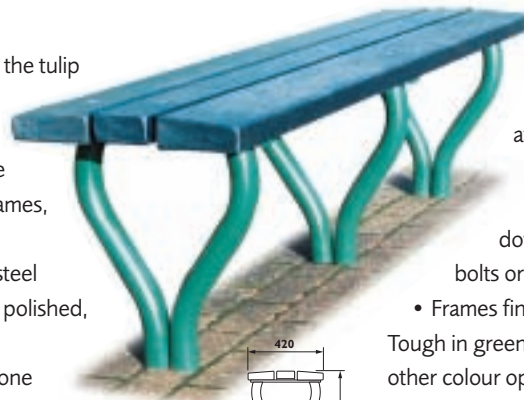

Sheffield Bench

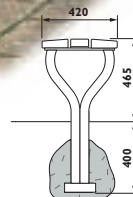

- Supplied with extended legs (for concreting in), as standard. Also available, at additional cost, with pedestal base legs (for bolting down).

• Pedestal base option can be bolted down with K1 rawl bolts, K4 extended rawl bolts or K12 extended rawl bolts

- Frames finished in either Acrylic Coating or Street-Tough in green 14C39 as standard (see page 82), eleven other colour options at no extra cost (see page 85)
- Stainless steel pin-in-socket fastenings as standard
- Supplied as separate boards and frames, requiring assembly
- For installation recommendations see page 44

NEATH BENCH

A development of our Prestatyn bench, with the same wider, shaped, boards as the Stirling and Tenby. It is suitable for general park, play area and street use.

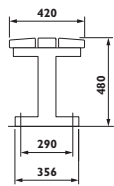

- Two tapered 45/55 x 145mm and one 50 x 95mm polyboard in black only
- Frames 50 x 50 x 3mm hollow with 50 x 100 x 3mm hollow legs
- Length 1800mm, weight approx. 42kg
- Supplied with extended legs (for concreting in), as standard. Also available with either pedestal base legs (for bolting down), or ground anchoring version (see pages 74 - 75).
- Pedestal base option can be bolted down with K3 rawl bolts, or K10 extended rawl bolts
- Frames finished in either Acrylic Coating or Street-Tough in red RAL 3001 as standard (see page 82), eleven other colour options at no extra cost (see page 85)



Neath Bench

- Stainless steel pin-in-socket fastenings as standard
- Supplied as separate boards and frames, requiring assembly
- For installation recommendations see page 44

PRESTATYN BENCH

This economical bench is the polyboard equivalent of our Chirk design, and is particularly suitable for school playgrounds, and children's recreational areas. The frames are dark green 14C40 as standard, though the black frames illustrated here are an option at no extra cost.

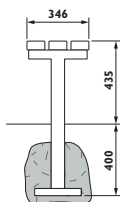

- Polyboards 50 x 95mm
- Polyboards in brown as standard, also available in black, (or blue, green, red or yellow at additional cost)
- Frames 50 x 50 x 3mm hollow with 50 x 75 x 3mm legs
- Length 1800mm, weight approx. 36kg
- Supplied with extended legs (for concreting in), as standard. Also available with either pedestal base legs (for bolting down), or ground anchoring version (see pages 74 - 75)
- Pedestal base option can be bolted down with K3 rawl bolts, or K10 extended rawl bolts
- Frames finished in either Acrylic Coating or Street-Tough in



Prestatyn Bench with blue boards

- dark green 14C40 as standard (see page 82), eleven other colour options at no extra cost (see page 85)
- Stainless steel pin-in-socket fastenings as standard
- Supplied as separate boards and frames, requiring assembly
- For installation recommendations see page 44

HEATHLAND PICNIC UNIT



Heathland Picnic Unit

An integral picnic unit with three frames to properly support the recycled plastic boards. Red, yellow, blue or green polyboards give this unit real impact for play areas.

- Polyboards 50 x 95mm
- Polyboards in brown as standard, also available in black, (or blue, green, red or yellow at additional cost)
- Frames 50 x 50 x 3mm hollow, 50 x 75 x 3mm hollow table legs

- Length 1800mm, weight approx. 123kg
- Pedestal base (for bolting down) as standard
- To concrete the unit in use K13C (225mm long), or K14C (400mm long) galvanised ground fixing extensions, secured by tamper resistant coachbolts, see above

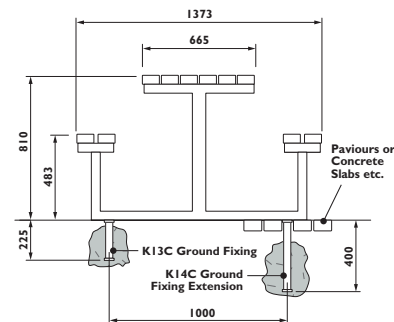

- To bolt the unit down use K3 rawl bolts, or K10 extended rawl bolts, see above and page 61
- Frames finished in either Acrylic Coating or Street-Tough in dark green 14C40 as standard (see page 82), eleven other colour options at no extra cost (see page 85)
- Supplied as separate boards and frames, requiring assembly

Polyboard Range

FLINT BIN

This bin has polyboard slats riveted to welded steel frames. The lidded version has galvanised steel shrouds around the top part of the bin, underneath the polyboards, to reduce the risk of it catching fire. We also manufacture an extra large 220 litre open top bin with polyboard slats, the Portsmouth, illustrated below. The recent availability of recycled plastic in a range of bright colours makes these bins particularly suitable for play areas.

- Legs 40 x 40 x 2.5mm hollow
- Slats 30 x 100mm in black or brown as standard. Red, green, blue and yellow slats available at additional cost.
- Galvanised 22 swg sheet steel liner with 6mm wired edge, drain holes and handle
- Approx. capacity 110 litres
- Supplied with extended legs (for concreting in), as standard. Also available with pedestal base legs (for bolting down)
- Pedestal base option can be bolted down with K1 rawl bolts, or K4 extended rawl bolts
- Single post mounting version available, extended (for concreting in) as standard, or flanged, for ground anchoring (see pages 74 - 75)
- Frames finished in either Acrylic Coating or Street-Tough finish in brown 08B29, or black as standard (See page 82)
- Weight approx. Lidded 73kg. Open top 53kg.
- Supplied fully assembled
- For installation recommendations see page 55

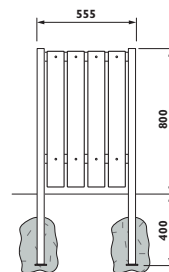
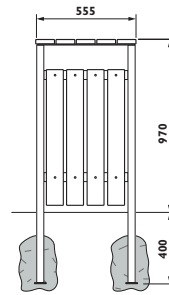

PORTSMOUTH BIN

- Legs 40 x 40 x 2.5mm hollow
- Slats 30 x 100mm in brown or black as standard. 30 x 100mm red, green, blue and yellow slats available at additional cost.
- Galvanised 22 swg sheet steel liner with 6mm wired edge, drain holes and lift-out handles
- Approx. capacity 220 litres
- Supplied with extended legs (for concreting in), as standard. Also available with pedestal base legs (for bolting down)
- Pedestal base option can be bolted down with K1 rawl bolts, or K4 extended rawl bolts
- Frames finished in either Acrylic Coating or Street-Tough finish in brown 08B29, or black as standard (See page 77)

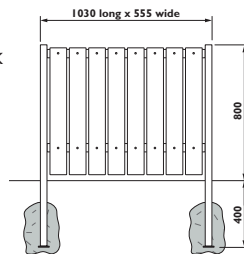

- Weight approx. 80kg.
- For installation recommendations see page 55

Summary of fixing options available for Polyboard Range

	Pedestal Base	Extended Legs	Single Post Mounting	Ground Anchor	K1	K1T	K3	K3T	K4	K4T	K10	K10T	K12	K13C	K14C
Stirling	•	•			•	•			•	•			•		
Tenby	•	•		•			•	•			•	•			
Colwyn	•	•		•			•	•			•	•			
Barmouth	•	•		•	•				•	•			•		
Sheffield	•	•		•	•				•	•			•		
Neath	•	•		•			•	•			•	•			
Prestatyn	•	•		•			•	•			•	•			
Heathland	•						•	•			•	•		•	•
Flint	•	•	•	•	•				•	•					
Portsmouth	•	•			•	•			•	•					